

SIMPSON TECHNOLOGIES CORPORATION

Corporate Profile – 2012

Celebrating 100 Years of Service to the
Global Metalcasting Industry



Simpson Technologies Corporation

A Five Generation Family Owned Business Since 1912

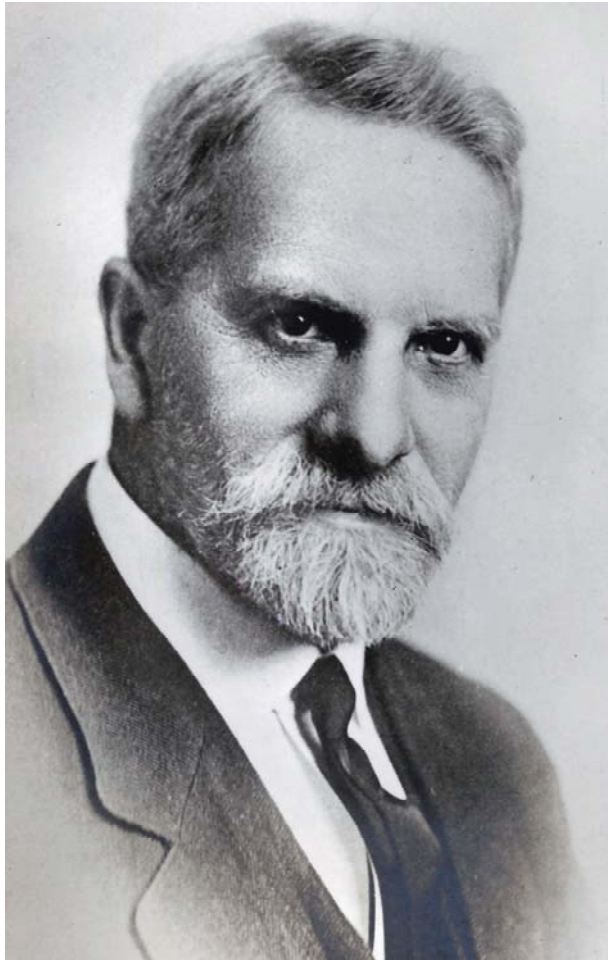

Left

Peter L. Simpson traveled from Scotland to Canada and finally the United States to begin Simpson Technologies in 1912.

Left and below

The original product was the Simpson Mix-Muller. Tens of thousands of Simpson mixers have been supplied to industries worldwide.



SYSTEM SIMPSON... OPTIMIZED SOLUTIONS DESIGNED FOR SPECIFIC NEEDS

WWW.SIMPSONGROUP.COM



Our Mission

To achieve consistent, profitable growth for our stakeholders through the innovative design, efficient manufacture and superior technical support of high quality engineered products for industrial applications in global markets, with emphasis on continually strengthening our position as a leading supplier to the foundry industry.



SYSTEM SIMPSON... OPTIMIZED SOLUTIONS DESIGNED FOR SPECIFIC NEEDS

WWW.SIMPSONGROUP.COM



Simpson Technologies Value Proposition

A Global Brand

Every Foundry is Different

To obtain the full potential from any green sand molding plant Simpson Technologies brings a full portfolio of continually advancing technologies that can be matched to the specific needs of the foundry. Whether the application is for a small jobbing steel foundry or a high production automotive iron or aluminum foundry we deliver an optimized solution in order to maximize your competitiveness and profitability. Specializing in the field of molding sand preparation and control, Simpson Technologies builds on nearly 100 years of experience providing innovative, integrated technologies with uniquely effective performance to the world's metal casting industry. By continuously developing a full range of proven, integrated sand preparation & control technologies Simpson can benefit any size or type of foundry by providing a complete solution from a single source that best -

- gives consistently high quality sand preparation system performance with minimal process variation, and
- minimizes the total cost of operation in terms of supervision, energy, raw materials and maintenance, and
- minimizes the total capital cost to acquire and install the equipment.

These benefits create value for a foundry by enabling it to produce molding sand which maximizes the potential of their casting plant to produce high value, high profit metal castings.

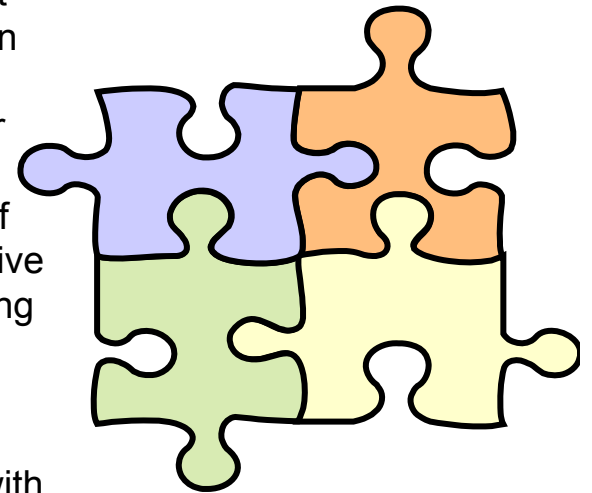

SYSTEM SIMPSON... OPTIMIZED SOLUTIONS DESIGNED FOR SPECIFIC NEEDS

WWW.SIMPSONGROUP.COM



A Global Brand – The largest portfolio of sand preparation and control equipment in the world.

Growth through Acquisition

- ☑ Dietert automation products (1995)
- ☑ Beardsley & Piper LLC (1998)
- ☑ R. Gerosa SRL sand laboratory equipment (1999)
- ☑ Hartley Controls Corporation (2000)
- ☑ +GF+/DISA sand laboratory equipment (2008)

Growth through Strategic Alliances/Joint Ventures

- ☑ Sintokogio, Ltd. (Licensee in Japan- 1960)
- ☑ Wesman Simpson Technologies Pvt. Ltd. (Joint Venture - 1998)
- ☑ Küttner do Brasil (Licensee in Brazil - 1999)

Growth through Internal Product Development

- ☑ Simpson CSM series core sand mixers (1993)
- ☑ B&P 150B Speedmullor (1999)
- ☑ Many items of sand testing equipment (1991 – 2012)

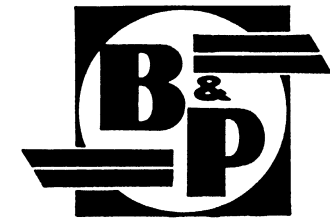

SYSTEM SIMPSON... OPTIMIZED SOLUTIONS DESIGNED FOR SPECIFIC NEEDS

WWW.SIMPSONGROUP.COM



Simpson Technologies Corporation

Strategy: Global Simpson



SYSTEM SIMPSON... OPTIMIZED SOLUTIONS DESIGNED FOR SPECIFIC NEEDS

WWW.SIMPSONGROUP.COM



Simpson Technologies

A Global Brand

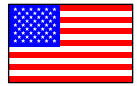

Simpson Technologies Corp.

- *Aurora, Illinois (1912)*



Simpson Technologies GmbH

- *Steinhausen, Switzerland (1967)*



Wesman Simpson Technologies Pvt. Ltd.

- *Calcutta, India (1998)*



Sintokogio, Ltd.

- *Nagoya, Japan*
- *Licensee since 1960*



Ricardo Gerosa SRL

- *Rosario, Argentina*
- *Partner since 1991*



Küttner do Brasil

- *Sao Paulo, Brazil*
- *Licensee since 1999*

SYSTEM SIMPSON... OPTIMIZED SOLUTIONS DESIGNED FOR SPECIFIC NEEDS

WWW.SIMPSONGROUP.COM



Simpson Technologies

Region 1 – North America

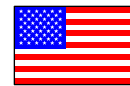

Simpson Technologies Corporation

751 Shoreline Drive
Aurora, IL 60504-6194
United States of America
Tel: (630) 978-0044
Fax: (630) 978-0068

SYSTEM SIMPSON... OPTIMIZED SOLUTIONS DESIGNED FOR SPECIFIC NEEDS

WWW.SIMPSONGROUP.COM



Simpson Technologies GmbH

Global Simpson – In Europe, Africa, The Middle East & Russia

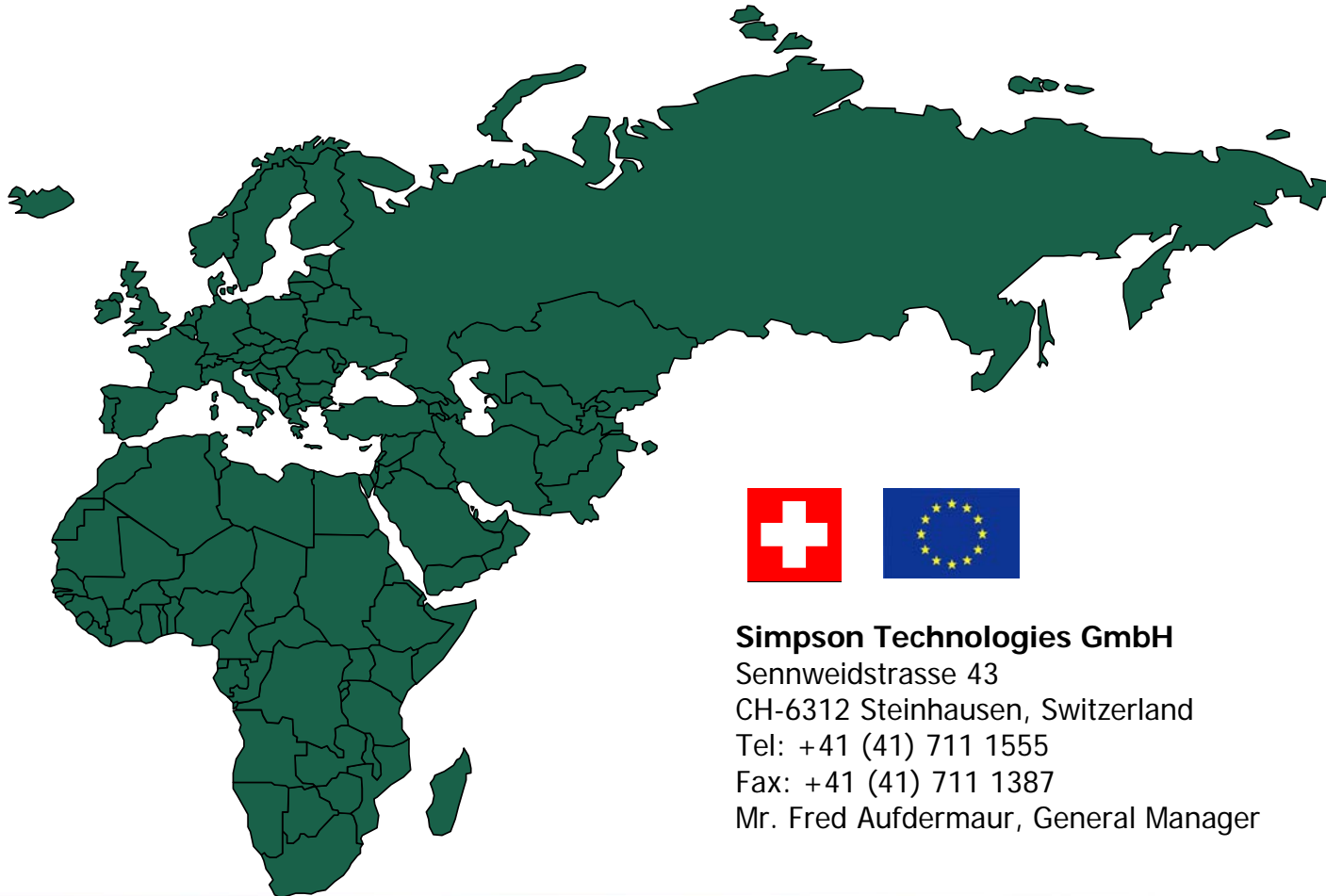

Simpson Technologies GmbH

Sennweidstrasse 43

CH-6312 Steinhausen, Switzerland

Tel: +41 (41) 711 1555

Fax: +41 (41) 711 1387

Mr. Fred Aufdermaur, General Manager



SYSTEM SIMPSON... OPTIMIZED SOLUTIONS DESIGNED FOR SPECIFIC NEEDS

WWW.SIMPSONGROUP.COM



Simpson Technologies

Region 3 – India

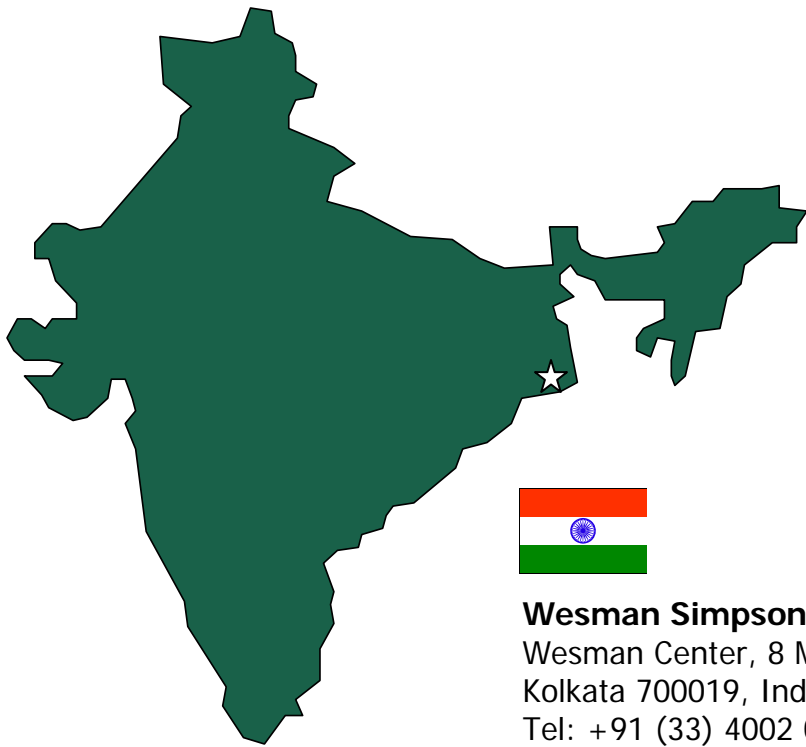

Wesman Simpson Technologies Pvt. Ltd
Wesman Center, 8 Mayfair Road
Kolkata 700019, India
Tel: +91 (33) 4002 0300
Fax: +91 (33) 2290 8050
Mr. Atish Mitra, Senior Manager



SYSTEM SIMPSON... OPTIMIZED SOLUTIONS DESIGNED FOR SPECIFIC NEEDS

WWW.SIMPSONGROUP.COM



Simpson Technologies

Region 4 – South America



Mr. Jose Lobo - General Manager of Sinto de Mexico, Mr. Bruce Dienst - President & COO of Simpson Technologies and Jörg Hagedorn - Managing Director of Küttner do Brasil stand in front of a recently completed Model #85B Speedmullor produced for the SADA Siderurgia foundry by Küttner in Brazil.

SYSTEM SIMPSON... OPTIMIZED SOLUTIONS DESIGNED FOR SPECIFIC NEEDS

WWW.SIMPSONGROUP.COM



Simpson Technologies

Region 5 – Asia

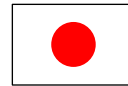
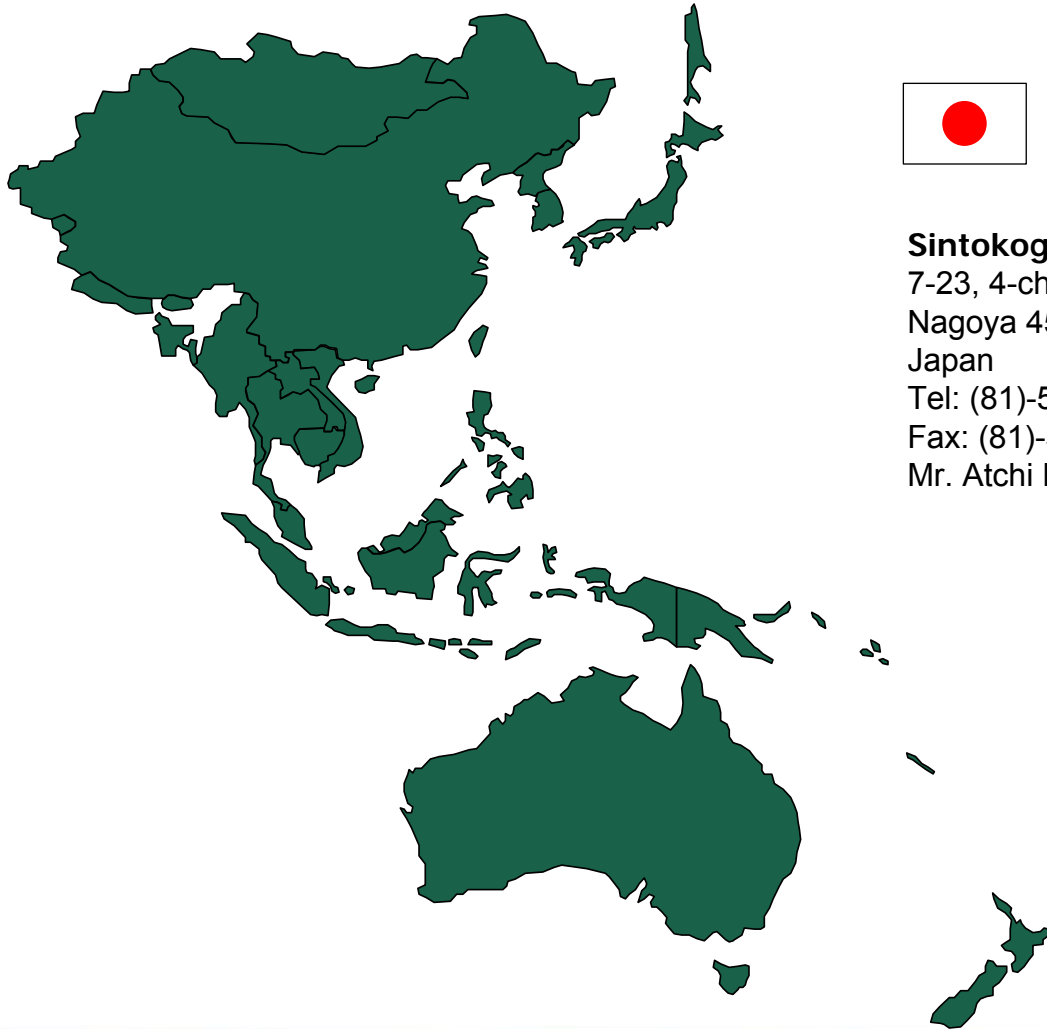

Sintokogio Ltd

7-23, 4-chome, Mei-eki, Nakamura-ku,
Nagoya 450-0002

Japan

Tel: (81)-52-582-9211

Fax: (81)-52-586-2279

Mr. Atchi Nagai, President

SYSTEM SIMPSON... OPTIMIZED SOLUTIONS DESIGNED FOR SPECIFIC NEEDS

WWW.SIMPSONGROUP.COM



Simpson Technologies

Region 5 – Asia

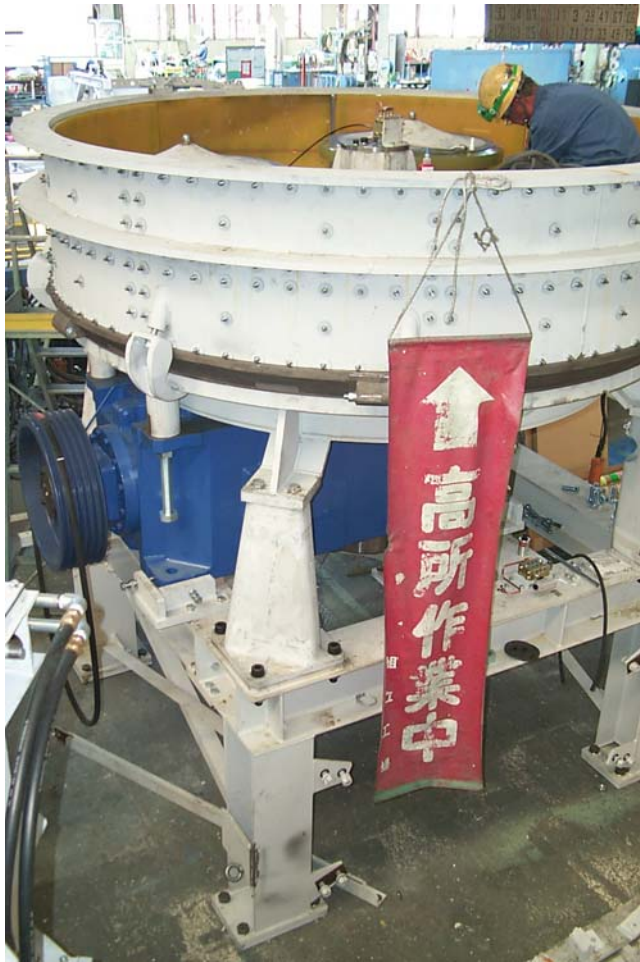

EQUIPMENT

- #100B-250 Simpson Speedmullor (2x)
- #18Mk2/2552 Simpson+Hartley Compactability Controller (2x)

Fukushima Steel Works Co. Ltd

EQUIPMENT

- #100B-250 Simpson Speedmullor
- #18Mk2/2552 Simpson+Hartley Compactability Controller

MANUFACTURED IN JAPAN UNDER LICENSE BY
Sintokogio Ltd. – Nagoya, Japan



SYSTEM SIMPSON... OPTIMIZED SOLUTIONS DESIGNED FOR SPECIFIC NEEDS

WWW.SIMPSONGROUP.COM



Simpson Technologies Corporation

Strategy: Simpson Solutions



SYSTEM SIMPSON... OPTIMIZED SOLUTIONS DESIGNED FOR SPECIFIC NEEDS

WWW.SIMPSONGROUP.COM



Sand Preparation - System Simpson

Optimized Solutions Designed for Specific Needs

OPTIMIZING VERSATILITY • PRODUCTIVITY • EFFICIENCY

A COOLING AND PRE-CONDITIONING

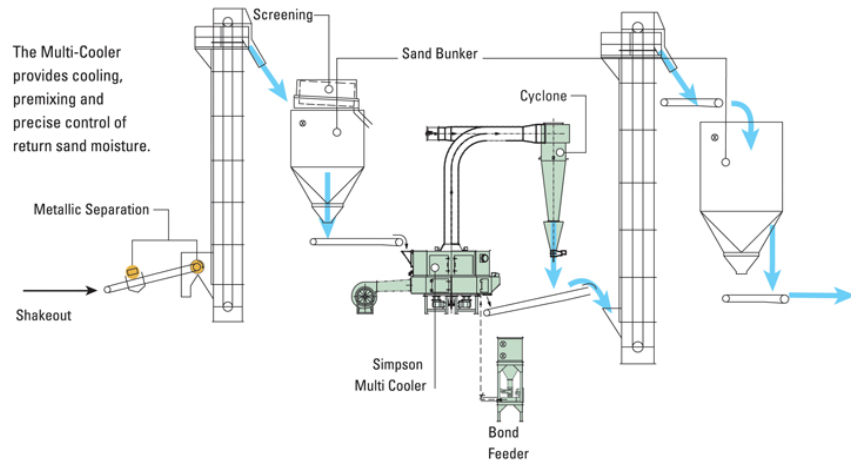

B MULLING & CONTROL

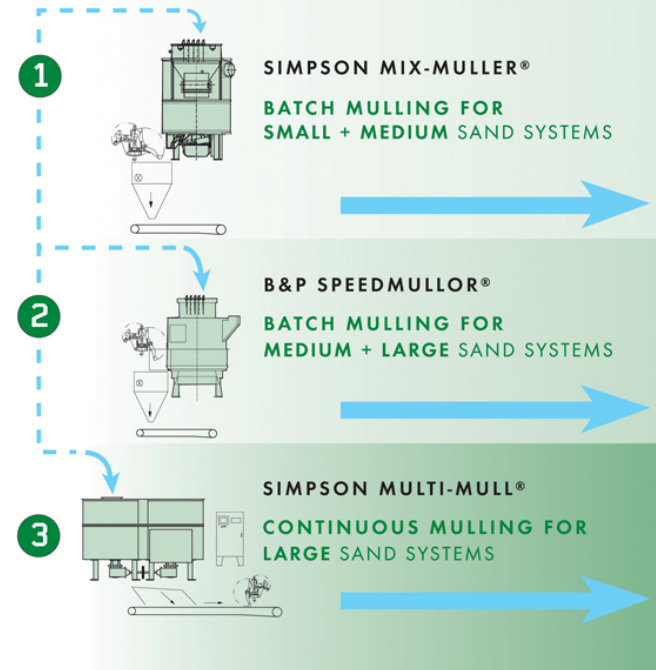

C MOLDING



SYSTEM SIMPSON... OPTIMIZED SOLUTIONS DESIGNED FOR SPECIFIC NEEDS

WWW.SIMPSONGROUP.COM



System Simpson - Simpson Multi-Cooler®

Pre-Conditioning makes you more Competitive

DESCRIPTION

Continuous sand cooling and pre-conditioning system operating on the principal of evaporative cooling

APPLICATION

Sand systems with return sand temperatures above 49° C and/or wide variations in return sand properties.

FEATURES

- Intensive pre-mixing of return sand with back-blending and a controlled retention system.
- High efficiency, low cost evaporative cooling of sand to below 49° C or 10° C above ambient, whichever is higher.
- Discharge moisture increased and stabilized at 2.0% +/- 0.2%
- Rugged design for low cost of operation and dependability.
- Seven (7x) production models from 22 tph to 270 tph capacities depending upon the application

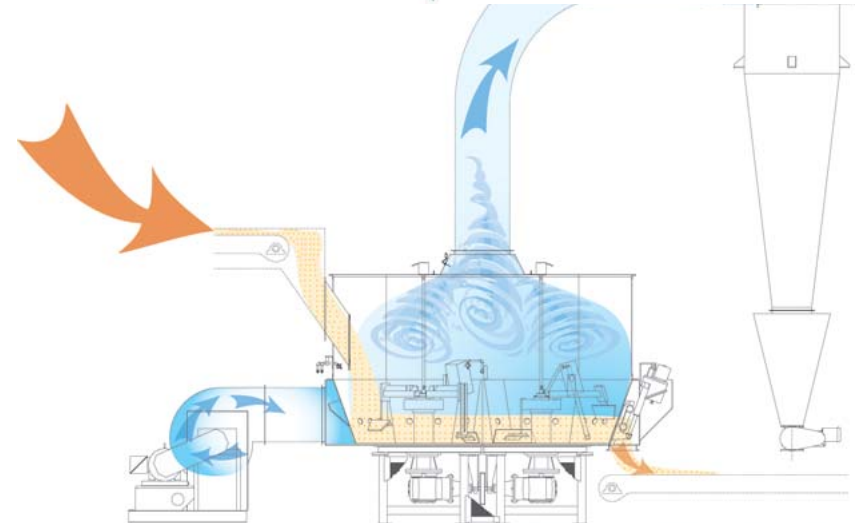

SYSTEM SIMPSON... OPTIMIZED SOLUTIONS DESIGNED FOR SPECIFIC NEEDS

WWW.SIMPSONGROUP.COM



System Simpson - Simpson Mix-Muller®

Versatility makes you more Competitive

DESCRIPTION

Medium-speed, high-intensity, muller-type mixer for batch operation

APPLICATION

Small to medium sized sand preparation systems, and the most difficult mixing applications.

FEATURES

- Adaptive tooling changes to mix requirements automatically
- Power of Mulling provides maximum energy efficiency
- Larger batch and longer cycle times for better control in difficult applications
- Rugged design for dependability
- Integrated with Hartley 18Mk2/2552 on-line compactability control system
- Seven (7x) production models up to 3,810 kg. batch size

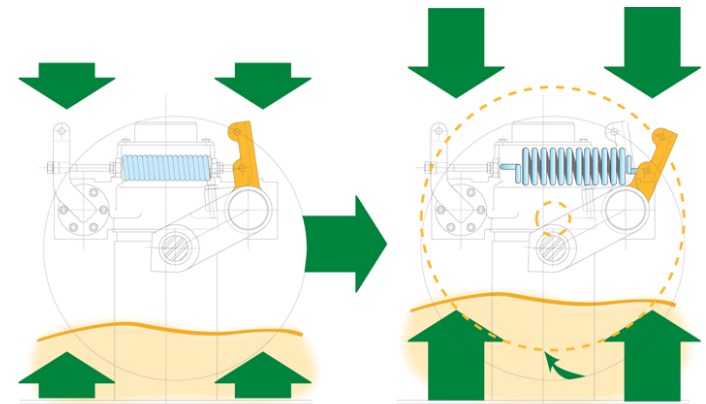

SYSTEM SIMPSON... OPTIMIZED SOLUTIONS DESIGNED FOR SPECIFIC NEEDS

WWW.SIMPSONGROUP.COM



System Simpson – Speedmullor®

PRODUCTIVITY makes you more **Competitive**

DESCRIPTION

High-speed, high-intensity, muller-type mixer for batch operation

APPLICATION

Medium-to large-sized sand preparation systems that still require some versatility in throughput or product produced.

FEATURES

- The ORIGINAL Speedmullor designed by Beardsley & Piper and installed in more than 1,000 foundries worldwide
- High productivity from short cycle times
- More energy efficient than turbine mixers
- Integrated with inlet blower to provide secondary cooling
- Integrated with Hartley 18Mk2/2552 on-line compactability control system
- Seven (7x) production models up to 3,400 kg. batch size

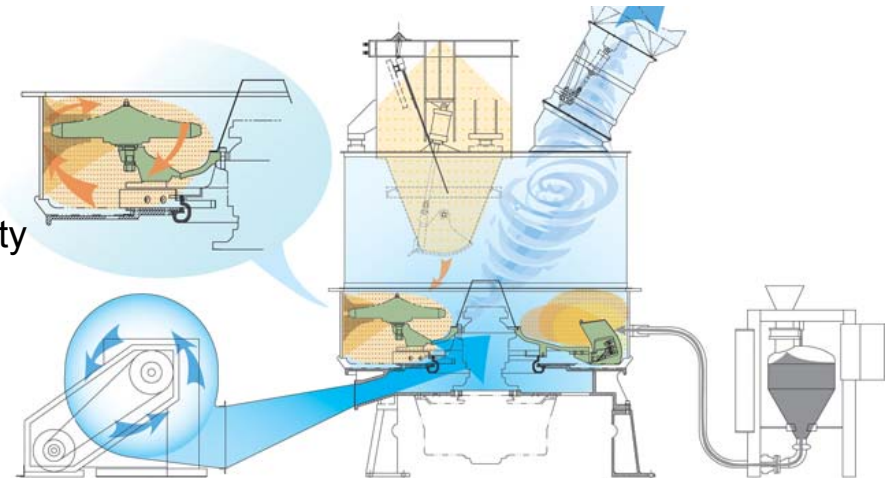

SYSTEM SIMPSON... OPTIMIZED SOLUTIONS DESIGNED FOR SPECIFIC NEEDS

WWW.SIMPSONGROUP.COM



System Simpson – Simpson Multi-Mull®

EFFICIENCY makes you more Competitive

DESCRIPTION

Medium-speed, high-intensity, muller-type mixer for continuous operation

APPLICATION

Medium-to large-sized sand preparation systems with consistently high production volumes seeking maximum efficiency and the least cost of operation.

FEATURES

- The only continuous mixer widely accepted for the production of bentonite bonded molding sand
- Counter rotating mixing tool sets provide continuous back-blending of material flowing through the mixer.
- Retention time is automatically controlled to maintain consistency.
- The most energy efficient molding sand mixer in the world
- Integrated with Hartley 17Mk2/2552 on-line compactability control system
- Eight (8x) production models up to 400 tph

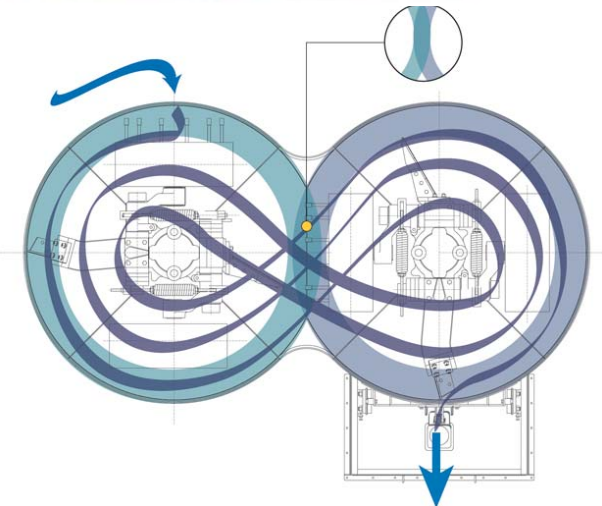
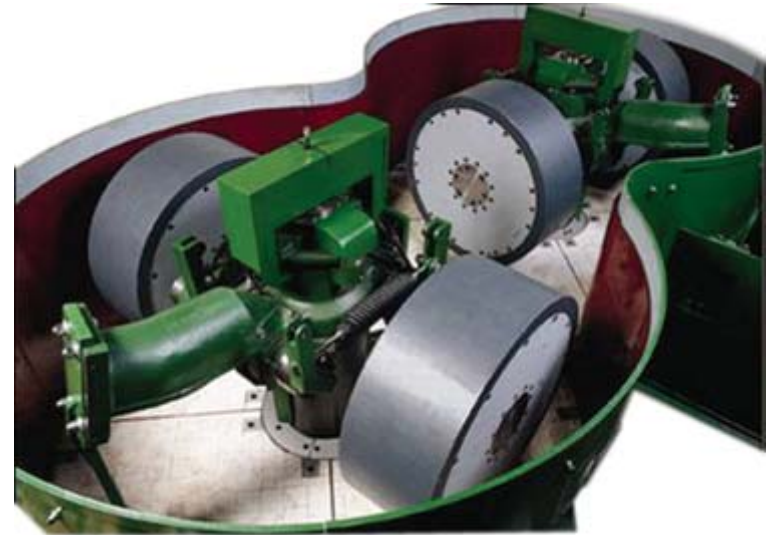

SYSTEM SIMPSON... OPTIMIZED SOLUTIONS DESIGNED FOR SPECIFIC NEEDS

WWW.SIMPSONGROUP.COM



System Simpson – Simpson+Hartley®

CONSISTENCY makes you more **Competitive**

DESCRIPTION

A complete mixer group control and automation system.

APPLICATION

For the automation and control of mix preparation and machine function for any make and model of green sand mixer..

FEATURES

- 4th generation design developed from the experience of more than 500 installations in more than 30 countries in all types of foundries and all types of mixers.
- Rugged design is easy to operate and maintain
- Provides complete automation and control of all mixer group functions
- Typical performance in fully automatic operation is to control compactability to +/- 3 points in 90%+ of tests
- Two (2x) models, each available in batch and continuous mixer versions, are easily adapted to any application.



SYSTEM SIMPSON... OPTIMIZED SOLUTIONS DESIGNED FOR SPECIFIC NEEDS

WWW.SIMPSONGROUP.COM



System Simpson – Simpson Pro-Claim[®]

RECYCLING makes you more **Competitive**

DESCRIPTION

Continuous, fully automatic, sand reclaimer operating on the principal of pneumatic scrubbing.

APPLICATION

Bentonite bonded or chemically bonded sand systems in any size or type of foundry.

FEATURES

- 3rd generation design based on the experience of more than 500 installations since including applications in nearly every combination of binder system, sand type and foundry.
- Intensive cleaning of individual sand grains is accomplished with simple and inexpensive pneumatic scrubbing.
- Adjustable gates allow users to easily change the retention time to obtain optimal reclamation performance.
- Operation is continuous and requires no operator.
- Demonstration and testing laboratories in the United States and Europe are available to verify system performance on your sand.
- Three (3x) production models provide capacity of up to 10 tph depending on the application.



SYSTEM SIMPSON... OPTIMIZED SOLUTIONS DESIGNED FOR SPECIFIC NEEDS

WWW.SIMPSONGROUP.COM



System Simpson – Simpson+Gerosa®

KNOWLEDGE makes you more Competitive

DESCRIPTION

A complete line of more than 70 advanced instruments and accessories for foundry sand testing.

APPLICATION

Precision testing of all properties of foundry molding sand, core sand and raw materials.

FEATURES

- More advanced, digital electronic designs are more accurate and more repeatable than conventional sand testing equipment designs.
- Easy to use and calibrate to traceable standards.
- An important quality control tool for every foundry that is economical to purchase and operate.
- Improved capabilities provide for better sand testing procedures than what is possible with older design technology.



SYSTEM SIMPSON... OPTIMIZED SOLUTIONS DESIGNED FOR SPECIFIC NEEDS

WWW.SIMPSONGROUP.COM



System Simpson – Simpson sand testing

KNOWLEDGE makes you more Competitive

DESCRIPTION

A complete line of more than 50 advanced instruments, former +GF+ DISA design, and accessories for foundry sand testing.

APPLICATION

Precision testing of all properties of foundry molding sand, core sand and raw materials.

FEATURES

- Easy to use and calibrate to traceable standards.
- An important quality control tool for every foundry that is economical to purchase and operate.



+GF+

SYSTEM SIMPSON... OPTIMIZED SOLUTIONS DESIGNED FOR SPECIFIC NEEDS

WWW.SIMPSONGROUP.COM

1812-2012
SIMPSON
TECHNOLOGIES

Simpson Technologies Corporation

Strategy: Simpson Service



SYSTEM SIMPSON... OPTIMIZED SOLUTIONS DESIGNED FOR SPECIFIC NEEDS

WWW.SIMPSONGROUP.COM



Simpson Service

33,000 Sq. Ft. (3,065 m²) US Headquarters, warehouse and research laboratory (built 1990)

9,500 Sq. Ft. (900 m²) CH Headquarters, warehouse and laboratory

Primary Technology Systems

- *Microsoft Dynamics AX 2012 ERP system*
- *Microsoft® Windows based network with MS Office business software*
- *Microsoft® CRM system*
- *www.simpsongroup.com*
- *CAD Based Engineering*
 - *Solidworks*
 - *AutoCad*
- *Desk-Top Publishing*
 - *Maintenance Instructions*
 - *Technical Documentation*

Shown here is a view of our parts distribution warehouse in suburban Chicago, IL USA with more than \$2 million in replacement parts inventory for all Simpson equipment available for immediate dispatch worldwide.



SYSTEM SIMPSON... OPTIMIZED SOLUTIONS DESIGNED FOR SPECIFIC NEEDS

WWW.SIMPSONGROUP.COM



Simpson Technologies Corporation

Strategy: Simpson Leads



SYSTEM SIMPSON... OPTIMIZED SOLUTIONS DESIGNED FOR SPECIFIC NEEDS

WWW.SIMPSONGROUP.COM



Simpson Leads in the Metalcasting Industry



American Foundry Society Peter L. Simpson Gold Medal National Presidents -

- Herbert Simpson (41-42)
- Bruce Simpson (55-56)
- Henry Dienst (96-97)



Giesserei-Verband der Schweiz GVS



Casting Industry Suppliers Assoc. Founding Member (1919) National Presidents -

- Herbert Simpson (31-32)
- Henry Dienst (78-80)
- Bruce Dienst (94-95)



Foundry Educational Foundation Founding Member (1947) National Presidents -

- Bruce Dienst (04-05)

SYSTEM SIMPSON... OPTIMIZED SOLUTIONS DESIGNED FOR SPECIFIC NEEDS

WWW.SIMPSONGROUP.COM



Simpson Leads in the Metalcasting Industry



**NORTHWESTERN
UNIVERSITY**

Peter L. Simpson Memorial Scholarship Fund at the Robert R. McCormick School of Engineering and Applied Science
Northwestern University – Evanston, IL USA



In 2009 Simpson established the Peter L. Simpson Endowment at the Foundry Educational Foundation with a donation of over \$700,000 to provide annual funding for research in molding sand preparation and control by leading American universities.



The Peter L. Simpson Gold Medal is one of five such medals given as the highest honor awarded an individual in the US Foundry Industry.

SYSTEM SIMPSON... OPTIMIZED SOLUTIONS DESIGNED FOR SPECIFIC NEEDS

WWW.SIMPSONGROUP.COM



Simpson Technologies Corporation

Recent References



SYSTEM SIMPSON... OPTIMIZED SOLUTIONS DESIGNED FOR SPECIFIC NEEDS

WWW.SIMPSONGROUP.COM



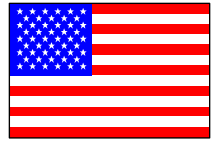

Charlotte Pipe & Foundry Co.

Charlotte, NC USA

1997

EQUIPMENT

- #MC-150 Simpson Multi-Cooler
- #23G-250 Simpson Multi-Mull
- #17Mk2-2552 Simpson+Hartley Compactability Control (2x)
- Simpson+Gerosa sand laboratory

APPLICATION

- Ductile Iron castings
- DISA 2013Mk5 (2x) molding line

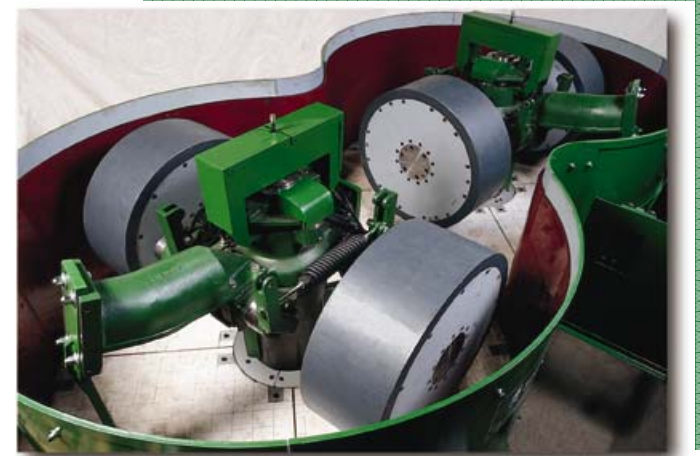

CHARLOTTE
PIPE AND FOUNDRY COMPANY

PRODUCTIVITY makes you more competitive

SYSTEM SIMPSON... OPTIMIZED SOLUTIONS DESIGNED FOR SPECIFIC NEEDS

WWW.SIMPSONGROUP.COM



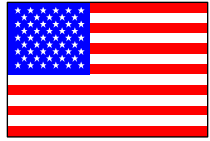

Grede Foundries Inc.

St. Cloud, MN USA

1999

EQUIPMENT

- #MC-250 Simpson Multi-Cooler
- #23G-250 Simpson Multi-Mull
- #3818 Simpson+Dietert Compactability Control
- Simpson+Gerosa sand laboratory
- Simpson CSM Core Sand Preparation System

APPLICATION

- Ductile Iron castings
- DISA 2070Mk5 molding line

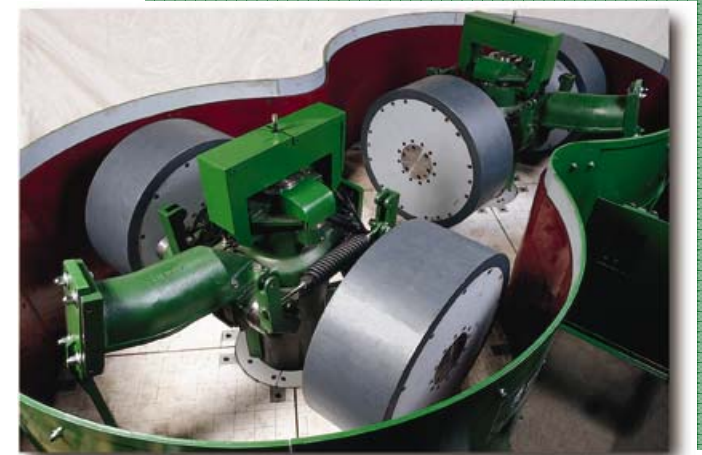

PRODUCTIVITY makes you more competitive

SYSTEM SIMPSON... OPTIMIZED SOLUTIONS DESIGNED FOR SPECIFIC NEEDS

WWW.SIMPSONGROUP.COM



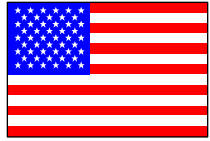

ASAMA Coldwater Manufacturing 1996

Coldwater, MI USA

EQUIPMENT

- #MC-100 Simpson Multi-Cooler
- #6G Simpson Mix-Muller
- #18Mk2-2552 Simpson+Hartley Compactability Control
- #90Mk2 Bond Dosing System
- Simpson+Gerosa sand laboratory

APPLICATION

- Iron castings
- +GF+ Impact molding line

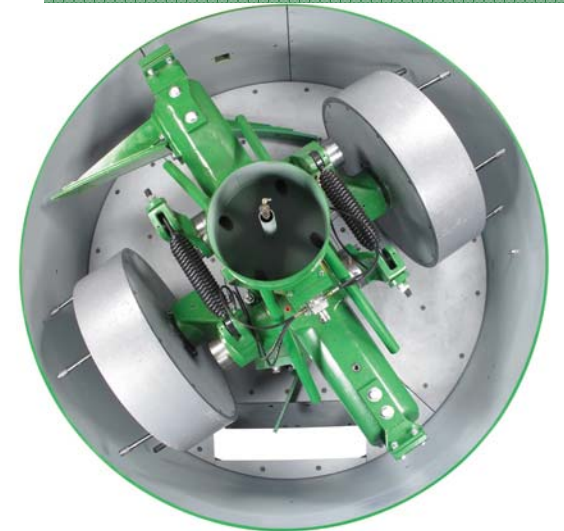

HONDA



Asama Coldwater
Manufacturing, Inc.

PRODUCTIVITY makes you more competitive

SYSTEM SIMPSON... OPTIMIZED SOLUTIONS DESIGNED FOR SPECIFIC NEEDS

WWW.SIMPSONGROUP.COM



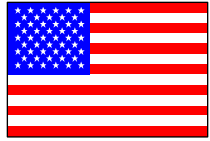

ThyssenKrupp Waupaca Foundry 2005

Etowah, TN USA

EQUIPMENT

- #MC-300 Simpson Multi-Coolers (2x)
- #150B Beardsley & Piper Speedmullor (5x)
- Simpson+Gerosa sand laboratory

APPLICATION

- Grey & Ductile Iron castings
- 4x DISA type molding lines

SALES PARTNER

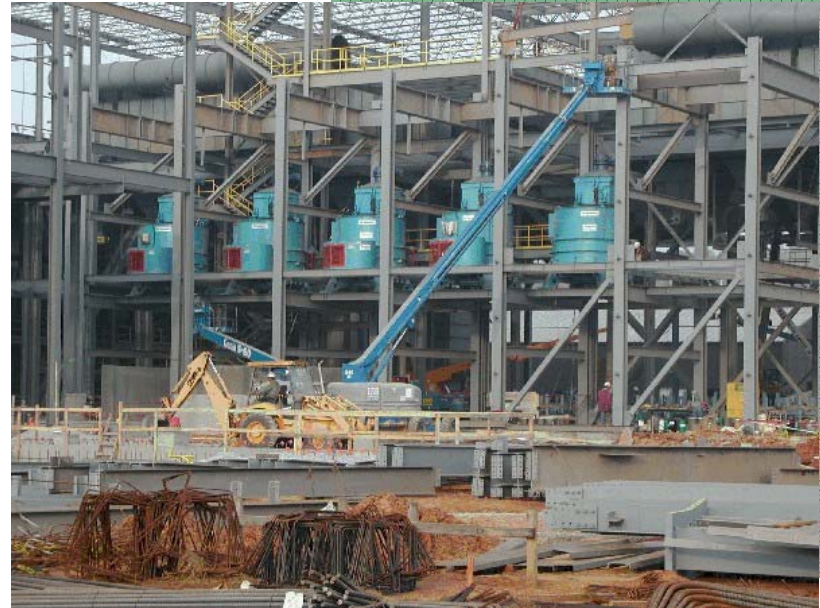

PRODUCTIVITY makes you more competitive

SYSTEM SIMPSON... OPTIMIZED SOLUTIONS DESIGNED FOR SPECIFIC NEEDS

WWW.SIMPSONGROUP.COM



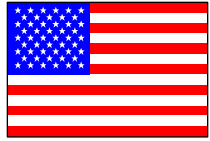

Goldens Foundry & Machine Co.

Cordele, GA USA

2005

EQUIPMENT

- #MC-150 Simpson Multi-Cooler
- #100B-250 Beardsley & Piper Speedmullor (2x)
- #18Mk2-2552 Simpson+Hartley Compactability Control (2x)
- #90Mk2 Bond Dosing System (2x)
- Simpson+Gerosa sand laboratory

APPLICATION

- Ductile Iron castings
- Savelli molding line



PRODUCTIVITY makes you more competitive

SYSTEM SIMPSON... OPTIMIZED SOLUTIONS DESIGNED FOR SPECIFIC NEEDS

WWW.SIMPSONGROUP.COM



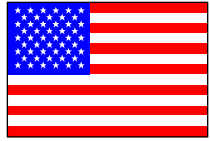

East Jordan Iron Works Inc.

Ardmore, OK USA

2005

EQUIPMENT

- #MC-250 Simpson Multi-Cooler
- #150B Beardsley & Piper Speedmullor (2x)
- #3818-NT Simpson+Dietert Compactability Control (2x)
- Simpson+Gerosa sand laboratory

APPLICATION

- Grey & Ductile Iron municipal castings
- HWS molding line



PRODUCTIVITY makes you more competitive

SYSTEM SIMPSON... OPTIMIZED SOLUTIONS DESIGNED FOR SPECIFIC NEEDS

WWW.SIMPSONGROUP.COM



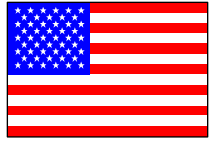

M&H Valve Co.

Anniston, AL USA

2005

EQUIPMENT

- #MC-250 Simpson Multi-Cooler
- #100B-250 Beardsley & Piper Speedmullor (2x)
- #18Mk2-2552 Simpson+Hartley Compactability Control (2x)
- #90Mk2 Bond Dosing System
- Simpson+Gerosa sand laboratory

APPLICATION

- Ductile Iron castings
- Model 250 DISA molding lines



M&H Valve Company 
A Division of McWane Inc

PRODUCTIVITY makes you more competitive

SYSTEM SIMPSON... OPTIMIZED SOLUTIONS DESIGNED FOR SPECIFIC NEEDS

WWW.SIMPSONGROUP.COM





CIFUNSA SA de CV

Irapuato, Mexico

1997

EQUIPMENT

- #100B-250 B&P Speedmullor (2x)
- #18Mk2-2552 Simpson+Hartley Compactability Control (2x)
- #90Mk2-5 Bond Dosing System (2x)
- Simpson+Gerosa sand laboratory

APPLICATION

- Ductile Iron castings
- 230 & 2070B DISA molding lines



PRODUCTIVITY makes you more competitive

SYSTEM SIMPSON... OPTIMIZED SOLUTIONS DESIGNED FOR SPECIFIC NEEDS

WWW.SIMPSONGROUP.COM





Teksid de Mexico

Monclova, Coah. Mexico

1997

EQUIPMENT

- #MC-250 Simpson Multi-Cooler
- #26G-350 Simpson Multi-Mull
- #3818 Simpson+Dietert Compactability Control
- Simpson+Gerosa sand laboratory

APPLICATION

- Ductile Iron castings
- HWS molding line

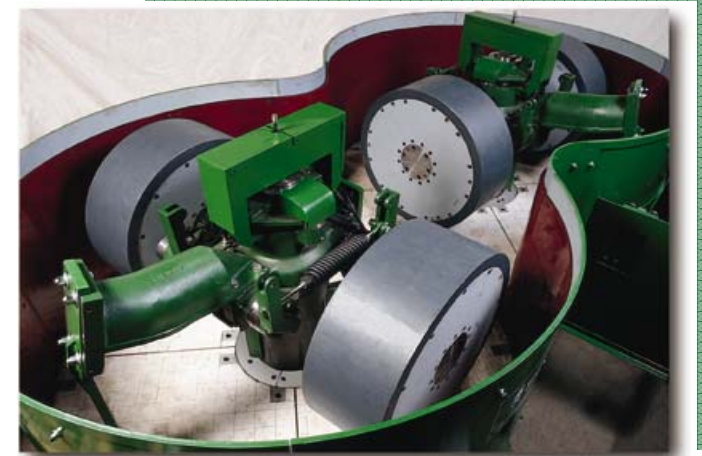

 **Teksid Hierro de México**

PRODUCTIVITY makes you more competitive

SYSTEM SIMPSON... OPTIMIZED SOLUTIONS DESIGNED FOR SPECIFIC NEEDS

WWW.SIMPSONGROUP.COM





Novocast Foundry SA de CV

Monterrey, NL Mexico

2001

EQUIPMENT

- #MC-250 Simpson Multi-Cooler
- #150B B&P Speedmullor (2x)
- #3818 Simpson+Dietert Compactability Control (2x)
- Simpson CSM Core Sand Preparation System
- Simpson+Gerosa sand laboratory

APPLICATION

- Ductile Iron castings
- 230 tph sand plant for an HWS Seiatsu molding line



Proeza **GREDE**

PRODUCTIVITY makes you more competitive

SYSTEM SIMPSON... OPTIMIZED SOLUTIONS DESIGNED FOR SPECIFIC NEEDS

WWW.SIMPSONGROUP.COM





Technocast SA de CV

Saltillo, Coah. Mexico

2006

EQUIPMENT

- #MC-300 Simpson Multi-Cooler
- #150B B&P Speedmullor (2x)
- #18Mk2-2552 Simpson+Hartley Compactability Control (2x)
- #90Mk2-5 Bond Dosing System (2x)
- Simpson+Gerosa sand laboratory

APPLICATION

- Ductile Iron castings
- Kunkel-Wagner molding line



TECHNOCAST

CATERPILLAR®

PRODUCTIVITY makes you more competitive

SYSTEM SIMPSON... OPTIMIZED SOLUTIONS DESIGNED FOR SPECIFIC NEEDS

WWW.SIMPSONGROUP.COM





Girlock SA (Pty) Ltd.
Isando, South Africa

2005

EQUIPMENT

- #MC-100 Simpson Multi-Cooler
- #85B Beardsley & Piper Speedmullor
- #18Mk2-2552 Simpson+Hartley Compactability Control
- #90Mk2 Bond Dosing System

APPLICATION

- Ductile Iron castings
- DISA 2013Mk5 molding line



PRODUCTIVITY makes you more competitive

SYSTEM SIMPSON... OPTIMIZED SOLUTIONS DESIGNED FOR SPECIFIC NEEDS

WWW.SIMPSONGROUP.COM





Trakya Döküm San. ve Tic. A.Ş.

Luleburgaz Kirklareli , Turkey

2005

EQUIPMENT

- #MC-200 Simpson Multi-Cooler
- #100B-250 Beardsley & Piper Speedmullor
- #2552 Simpson+Hartley Compactability Controller
- #90Mk2 Simpson+Hartley bond dosing system

APPLICATION

- Automotive castings
- Disamatic molding line

SALES PARTNER

FOSTEMA Ltd. Şti.



TRAKYA DÖKÜM

PRODUCTIVITY makes you more competitive

SYSTEM SIMPSON... OPTIMIZED SOLUTIONS DESIGNED FOR SPECIFIC NEEDS

WWW.SIMPSONGROUP.COM





Denizciler Dökümcülük San.Tic A.Ş 2007

Izmir, Turkey

EQUIPMENT

- #85B Beardsley & Piper Speedmullor
- #2552 Simpson+Hartley Compactability Controller

APPLICATION

- Grey & Ductile Iron castings
- Hunter molding lines

SALES PARTNER

FOSTEMA Ltd. Şti.



DENİZCİLER®
dökümcülük sanayi ve ticaret a.ş.

PRODUCTIVITY makes you more competitive

SYSTEM SIMPSON... OPTIMIZED SOLUTIONS DESIGNED FOR SPECIFIC NEEDS

WWW.SIMPSONGROUP.COM





Erkunt Sanayi A.Ş.

Ankara, Turkey

2007

EQUIPMENT

- #MC-150 Simpson Multi-Cooler
- #150B Beardsley & Piper Speedmullor
- #2552 Simpson+Hartley Compactability Controller
- #90Mk2 Simpson+Hartley bond dosing system

APPLICATION

- Engine blocks & automotive castings
- HWS Seiatsu molding line

SALES PARTNER

FOSTEMA Ltd. Şti.



PRODUCTIVITY makes you more competitive

SYSTEM SIMPSON... OPTIMIZED SOLUTIONS DESIGNED FOR SPECIFIC NEEDS

WWW.SIMPSONGROUP.COM





Leszczynska Fabryka Pomp Sp.

Leszno, Poland

2006

EQUIPMENT

- (2x) 2-Cell Simpson Pro-Claim

APPLICATION

- Green sand to core sand reclamation
- Combination mechanical/thermal reclamation plant

SALES PARTNER

IMF Srl. - Italy



PRODUCTIVITY makes you more competitive

SYSTEM SIMPSON... OPTIMIZED SOLUTIONS DESIGNED FOR SPECIFIC NEEDS

WWW.SIMPSONGROUP.COM





Scania CV AB

Södertälje, Sweden

2008

EQUIPMENT

- #2552 Simpson+Hartley Compactability Controller

APPLICATION

- Iron automotive castings
- Webac 100B Speedmullor mixer

SALES PARTNER

Karlebo Gjuteriteknik AB



SCANIA

www.scania.com

PRODUCTIVITY makes you more competitive

SYSTEM SIMPSON... OPTIMIZED SOLUTIONS DESIGNED FOR SPECIFIC NEEDS

WWW.SIMPSONGROUP.COM





Roslagsgjuteriet AB

Herräng , Sweden

2008

EQUIPMENT

- #2552 Simpson+Hartley Compactability Controller

APPLICATION

- Iron automotive castings
- Webac 66B Speedmullor mixer

SALES PARTNER

Karlebo Gjuteriteknik AB



www.roslagsgjut.se

PRODUCTIVITY makes you more competitive

SYSTEM SIMPSON... OPTIMIZED SOLUTIONS DESIGNED FOR SPECIFIC NEEDS

WWW.SIMPSONGROUP.COM





Vestas Nacelles A/S

Sweden, Norway & China

EQUIPMENT

- Four large sets of Simpson sand laboratory equipment including both former +GF+ and Simpson Gerosa machines

APPLICATION

- Vestas is a leading supplier worldwide of windmills. The equipment purchased is to equip a sophisticated chemically bonded sand testing laboratories in their facilities in four countries.

SALES PARTNER

Karlebo Gjuteriteknik AB



Euro 140,300 (US\$ 178,440)

PRODUCTIVITY makes you more competitive

SYSTEM SIMPSON... OPTIMIZED SOLUTIONS DESIGNED FOR SPECIFIC NEEDS

WWW.SIMPSONGROUP.COM

2009



Vestas

www.vestas.com





Hansgrohe AG

Schiltach, Germany

2009

EQUIPMENT

- A large set of Simpson sand laboratory equipment including a PVF-C Mini-Lab

APPLICATION

- Hansgrohe develops, manufactures and sells products concerned with sanitation technology under four brand names

SALES PARTNER

Simpson Technologies – Steinhausen, Switzerland



Euro 27,689 (US\$ 35,290)

PRODUCTIVITY makes you more competitive



hansgrohe

www.hansgrohe.com

SYSTEM SIMPSON... OPTIMIZED SOLUTIONS DESIGNED FOR SPECIFIC NEEDS

WWW.SIMPSONGROUP.COM





Federal Mogul Corporation

Patiala, Punjab, India

2007

EQUIPMENT

- #75B Beardsley & Piper Speedmullor
- #2552 Simpson+Hartley Compactability Controller
- #90Mk2 Simpson+Hartley bond dosing system

APPLICATION

- piston rings & cylinder liners
- SPM Stack molding molding machines
- 28 TPH capacity sand plant

SALES PARTNER

Wesman Simpson Technologies Pvt. Ltd.



PRODUCTIVITY makes you more competitive

SYSTEM SIMPSON... OPTIMIZED SOLUTIONS DESIGNED FOR SPECIFIC NEEDS

WWW.SIMPSONGROUP.COM





Federal Mogul Corporation

Bangalore, Karnataka, India

2007

EQUIPMENT

- #75B Beardsley & Piper Speedmullor
- #2552 Simpson+Hartley Compactability Controller
- #90Mk2 Simpson+Hartley bond dosing system

APPLICATION

- piston rings & cylinder liners
- SPM Stack molding molding machines
- 28 TPH capacity sand plant

SALES PARTNER

Wesman Simpson Technologies Pvt. Ltd.



PRODUCTIVITY makes you more competitive

SYSTEM SIMPSON... OPTIMIZED SOLUTIONS DESIGNED FOR SPECIFIC NEEDS

WWW.SIMPSONGROUP.COM





Siloé Cerise S.A.

Brazil

2006

EQUIPMENT

- #45B Beardsley & Piper Speedmullor

APPLICATION

- foundry

SALES PARTNER

Küttner do Brasil Equipamentos Siderúrgicos Ltda.

KÜTTNER



PRODUCTIVITY makes you more competitive

SYSTEM SIMPSON... OPTIMIZED SOLUTIONS DESIGNED FOR SPECIFIC NEEDS

WWW.SIMPSONGROUP.COM





MAHLE Metal Leve S.A.

Mogi Guaçu (SP) Brazil

2006

EQUIPMENT

- #85B Beardsley & Piper Speedmullor

APPLICATION

- Automotive castings

SALES PARTNER

Küttner do Brasil Equipamentos Siderúrgicos Ltda.

KÜTTNER



MAHLE

PRODUCTIVITY makes you more competitive

SYSTEM SIMPSON... OPTIMIZED SOLUTIONS DESIGNED FOR SPECIFIC NEEDS

WWW.SIMPSONGROUP.COM





Fundição Balancins Ltda.

Embu-Guaçu (SP) Brazil

2006

EQUIPMENT

- #85B Beardsley & Piper Speedmullor

APPLICATION

- Automotive castings

SALES PARTNER

Küttner do Brasil Equipamentos Siderúrgicos Ltda.

KÜTTNER



PRODUCTIVITY makes you more competitive

SYSTEM SIMPSON... OPTIMIZED SOLUTIONS DESIGNED FOR SPECIFIC NEEDS

WWW.SIMPSONGROUP.COM





Fundição Alca Ltda.

Nova Petópolis (RS) Brazil

2006

EQUIPMENT

- #55B Beardsley & Piper Speedmullor

APPLICATION

- Automotive castings

SALES PARTNER

Küttner do Brasil Equipamentos Siderúrgicos Ltda.

KÜTTNER



PRODUCTIVITY makes you more competitive

SYSTEM SIMPSON... OPTIMIZED SOLUTIONS DESIGNED FOR SPECIFIC NEEDS

WWW.SIMPSONGROUP.COM





WEG Motores Ltda.

Jaraguá do Sul, (SC) Brazil

2007

EQUIPMENT

- #150B Beardsley & Piper Speedmullor

APPLICATION

- electric motor castings

SALES PARTNER

Küttner do Brasil Equipamentos Siderúrgicos Ltda.

KÜTTNER



PRODUCTIVITY makes you more competitive

SYSTEM SIMPSON... OPTIMIZED SOLUTIONS DESIGNED FOR SPECIFIC NEEDS

WWW.SIMPSONGROUP.COM





Cercena S/A Indústria Metalúrgica 2007

Erechim, (RS) Brazil

EQUIPMENT

- #75B Beardsley & Piper Speedmullor

APPLICATION

- Automotive castings

SALES PARTNER

Küttner do Brasil Equipamentos Siderúrgicos Ltda.

KÜTTNER



CERCENA S/A
INDÚSTRIA METALÚRGICA

PRODUCTIVITY makes you more competitive

SYSTEM SIMPSON... OPTIMIZED SOLUTIONS DESIGNED FOR SPECIFIC NEEDS

WWW.SIMPSONGROUP.COM





Vulcamet S.A..

Rosario, Argentina

2007

EQUIPMENT

- #100B Beardsley & Piper Speedmullor

APPLICATION

- Automotive castings
- Disamatic molding line

SALES PARTNER

Küttner do Brasil Equipamentos Siderúrgicos Ltda.

KÜTTNER



PRODUCTIVITY makes you more competitive

SYSTEM SIMPSON... OPTIMIZED SOLUTIONS DESIGNED FOR SPECIFIC NEEDS

WWW.SIMPSONGROUP.COM

www.vulcamet.com.ar





First Automobile Works

2nd Foundry Plant, Changchun , China

1987

EQUIPMENT

- #MC-200 Simpson Multi-Cooler (2x)
- #23G-250 Simpson Multi-Mull (2x)
- #3818 Simpson+Dietert Compactability Controller (2x)

APPLICATION

- Automotive iron castings
- +GF+ Impact molding line
- DISA 2070 molding line



FAW

PRODUCTIVITY makes you more competitive

SYSTEM SIMPSON... OPTIMIZED SOLUTIONS DESIGNED FOR SPECIFIC NEEDS

WWW.SIMPSONGROUP.COM





Brembo Iron Foundry

Nanjing, Jiangsu Province, China

2001

EQUIPMENT

- #MC-150 Simpson Multi-Cooler (2x)

APPLICATION

- iron castings



 Nanjing Taining Iron Foundry Co., Ltd.

PRODUCTIVITY makes you more competitive

SYSTEM SIMPSON... OPTIMIZED SOLUTIONS DESIGNED FOR SPECIFIC NEEDS

WWW.SIMPSONGROUP.COM





Shanghai Kohler Co. Ltd.
Shanghai, China

2001

EQUIPMENT

- #26G Simpson Multi-Mull

APPLICATION

- iron castings

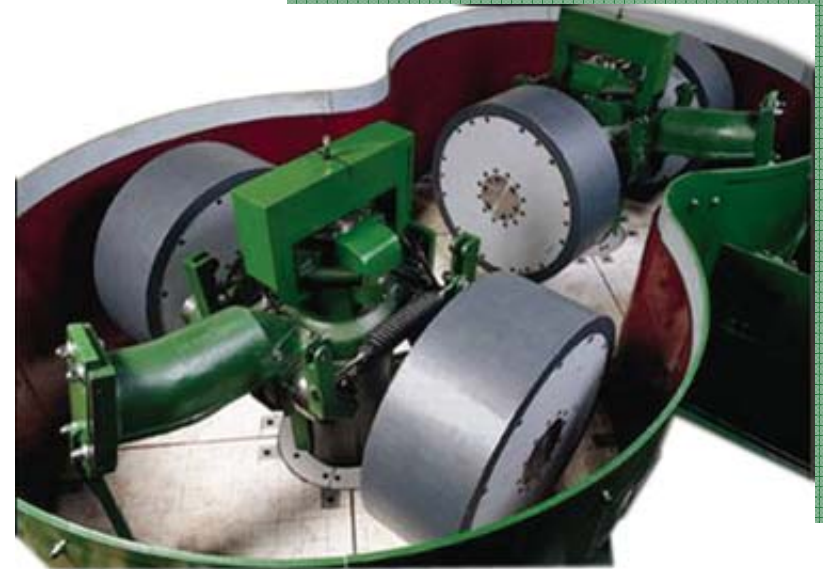

科 THE BOLD LOOK
勒 OF KOHLER
全 球 厨 卫 经 典

PRODUCTIVITY makes you more competitive

SYSTEM SIMPSON... OPTIMIZED SOLUTIONS DESIGNED FOR SPECIFIC NEEDS

WWW.SIMPSONGROUP.COM





Daehan Special Metal Co.

Koryung-Gun, South Korea

2002

EQUIPMENT

- #MC-100 Simpson Multi-Cooler
- #100B-200 Beardsley & Piper Speedmullor
- #18Mk2-2552 Simpson+Hartley Compactability Control
- #90Mk2 Bond Dosing System
- 2-Cell Pro-Claim

APPLICATION

- Ductile Iron castings
- DISA 2110 molding line



PRODUCTIVITY makes you more competitive

SYSTEM SIMPSON... OPTIMIZED SOLUTIONS DESIGNED FOR SPECIFIC NEEDS

WWW.SIMPSONGROUP.COM



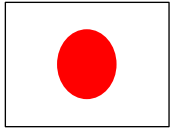

Aisin Takaoka Foundry Co.
Toyoda City Japan

2004

EQUIPMENT

- #MC-250 Simpson Multi-Cooler
- #100B-250 Beardsley & Piper Speedmullor (2x)
- #18Mk2-2552 Simpson+Hartley Compactability Control (2x)
- #90Mk2 Bond Dosing System

APPLICATION

- Ductile Iron castings
- Sinto ACE molding lines



PRODUCTIVITY makes you more competitive

SYSTEM SIMPSON... OPTIMIZED SOLUTIONS DESIGNED FOR SPECIFIC NEEDS

WWW.SIMPSONGROUP.COM





Takaoka Lioho (Tianjin) Industries

Tianjin, China

2007

EQUIPMENT

- Model #6G Simpson Mix-Mullers (2x)

APPLICATION

- Automotive castings
- Sinto Seiatu ACE molding line

MANUFACTURED IN JAPAN UNDER LICENSE BY
Sintokogio Ltd. – Nagoya, Japan



PRODUCTIVITY makes you more competitive

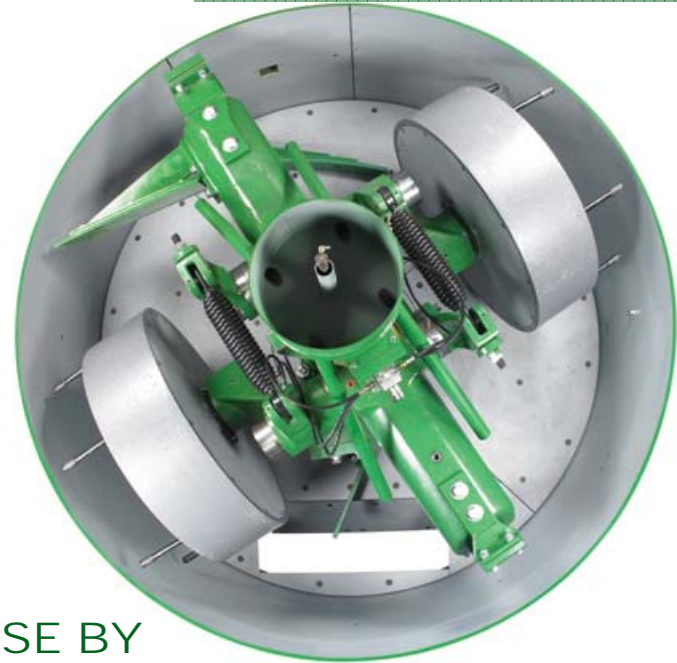

SYSTEM SIMPSON... OPTIMIZED SOLUTIONS DESIGNED FOR SPECIFIC NEEDS

WWW.SIMPSONGROUP.COM



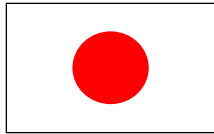

Kitagawa Iron Works Co., Ltd.

Saitama-shi, Saitama, Japan

2007

EQUIPMENT

- #100B-250 Beardsley & Piper Speedmullor
- #2552 Simpson+Hartley Compactability Controller

APPLICATION

- Automotive castings
- Sinto Seiatu ACE molding line

SALES PARTNER

Sintokogio Ltd. – Nagoya, Japan



KITAGAWA
Kitagawa Iron Works Co., Ltd.

PRODUCTIVITY makes you more competitive

SYSTEM SIMPSON... OPTIMIZED SOLUTIONS DESIGNED FOR SPECIFIC NEEDS

WWW.SIMPSONGROUP.COM



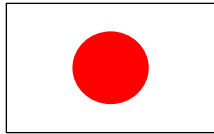

Sakabe Industry Co. Ltd.

Nishio-shi, Aichi, Japan

2007

EQUIPMENT

- #100B-200 Beardsley & Piper Speedmullor
- #2552 Simpson+Hartley Compactability Controller

APPLICATION

- Construction equipment castings
- Sinto Seiatu ACE molding line

SALES PARTNER

Sintokogio Ltd. – Nagoya, Japan



PRODUCTIVITY makes you more competitive

SYSTEM SIMPSON... OPTIMIZED SOLUTIONS DESIGNED FOR SPECIFIC NEEDS

WWW.SIMPSONGROUP.COM



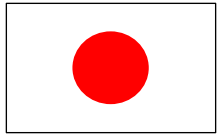

Asagoe Kogyo Co. Ltd.

Okayama-shi, Okayama, Japan

2007

EQUIPMENT

- #100B-250 Beardsley & Piper Speedmullor
- #2552 Simpson+Hartley Compactability Controller

APPLICATION

- Automotive & Construction equipment castings
- Sinto Seiatu ACE molding line

SALES PARTNER

Sintokogio Ltd. – Nagoya, Japan



PRODUCTIVITY makes you more competitive

SYSTEM SIMPSON... OPTIMIZED SOLUTIONS DESIGNED FOR SPECIFIC NEEDS

WWW.SIMPSONGROUP.COM





Dalian Bingshan Metal Technology Co., Ltd.

Dalian, Liaoning Province, China

2008

EQUIPMENT

- #MC-100 Simpson Multi-Cooler

APPLICATION

- Dalian Bingshan Metal Technology Co., Ltd. is a joint venture between Dalian Bingshan Group and Victaulic Company of America, The main products include high technology metal hardware, joint fittings for water system, scroll compressor casting parts for Sanyo, high pressure valves, automobile engine parts & joint fittings for railway

SALES PARTNER

Simpson Technologies (Changzhou), Ltd.
Changzhou City, Jiangsu Province, China



大连冰山金属技术有限公司
DALIAN BINGSHAN METAL TECHNOLOGY CO., LTD.

www.dbmt.com.cn

PRODUCTIVITY makes you more competitive

SYSTEM SIMPSON... OPTIMIZED SOLUTIONS DESIGNED FOR SPECIFIC NEEDS

WWW.SIMPSONGROUP.COM





China Yuchai International Ltd. 2008

Yulin City, Guangxi Province, China

EQUIPMENT

- #MC-200 Simpson Multi-Cooler

APPLICATION

- Yuchai is one of the top three manufacturers of light, medium and heavy duty diesel engines for trucks in China.

SALES PARTNER

Simpson Technologies (Changzhou), Ltd.
Changzhou City, Jiangsu Province, China



www.hlcorp.com

PRODUCTIVITY makes you more competitive

SYSTEM SIMPSON... OPTIMIZED SOLUTIONS DESIGNED FOR SPECIFIC NEEDS

WWW.SIMPSONGROUP.COM





Suzhou Xingye Foundry Materials 2008

Suzhou City, Jiangsu Province - China

EQUIPMENT

- A combination of some of the most advanced Simpson+Gerosa sand laboratory equipment including a High Temperature Compression Tester and a Hot Distortion Tester

APPLICATION

- Suzhou Xingye Corporation is a specialized foundry materials supplier to the Chinese foundry market. This new equipment will equip an advanced resin bonded sand testing laboratory.

SALES PARTNER

Simpson Technologies (Changzhou), Ltd.
Changzhou City, Jiangsu Province, China



蘇州市興業鑄造材料有限公司
蘇州市興業化工有限公司

www.chinaxingye.com

PRODUCTIVITY makes you more competitive

SYSTEM SIMPSON... OPTIMIZED SOLUTIONS DESIGNED FOR SPECIFIC NEEDS

WWW.SIMPSONGROUP.COM





Longgong (Fujian) Casting & Forging Co., Ltd.

Longyan City, Fujian Province, China

2008

EQUIPMENT

- #MC-200 Simpson Multi-Cooler

APPLICATION

- A new foundry for Longgong Group - a top 10 Chinese construction machinery maker – to produce iron casting for their construction machinery like forklifts, front end loaders & other earthmoving machinery

SALES PARTNER

Simpson Technologies (Changzhou), Ltd.
Changzhou City, Jiangsu Province, China



www.chinalonggong.com

PRODUCTIVITY makes you more competitive

SYSTEM SIMPSON... OPTIMIZED SOLUTIONS DESIGNED FOR SPECIFIC NEEDS

WWW.SIMPSONGROUP.COM





First Automobile Works

Changchun, Jilin Province, China

2008

EQUIPMENT

- #17Mk2/2552 Simpson+Hartley on-line control
- #23G-250 Simpson Multi-Mull discharge door upgrade
- #MC-200 Simpson Multi-Cooler discharge door upgrade

APPLICATION

- To update and improve the control of an existing #23G-250 Simpson Multi-Mull and MC-200 Simpson Multi-Cooler and to provide modernization of the sand plant control system.

SALES PARTNER

Simpson Technologies (Changzhou), Ltd.
Changzhou City, Jiangsu Province, China



www.faw-foundry.com.cn

PRODUCTIVITY makes you more competitive

SYSTEM SIMPSON... OPTIMIZED SOLUTIONS DESIGNED FOR SPECIFIC NEEDS

WWW.SIMPSONGROUP.COM





Dalian Bingshan Metal Technology Co., Ltd.

Dalian, Liaoning Province, China

2008

EQUIPMENT

- #85B Simpson Speedmullor
- #18Mk2/2552 Simpson+Hartley Controller

APPLICATION

• Dalian Bingshan Metal Technology Co., Ltd. is a joint venture between Dalian Bingshan Group and Victaulic Company of America, The main products include high technology metal hardware, joint fittings for water system, scroll compressor casting parts for Sanyo, high pressure valves, automobile engine parts & joint fittings for railway

SALES PARTNER

Simpson Technologies (Changzhou), Ltd.
Changzhou City, Jiangsu Province, China



大连冰山金属技术有限公司
DALIAN BINGSHAN METAL TECHNOLOGY CO., LTD.

www.dbmt.com.cn

PRODUCTIVITY makes you more competitive

SYSTEM SIMPSON... OPTIMIZED SOLUTIONS DESIGNED FOR SPECIFIC NEEDS

WWW.SIMPSONGROUP.COM





Shanghai Kohler Company, Ltd.

Shanghai City, China

2008

EQUIPMENT

- #17Mk2/2552 Simpson+Hartley on-line control
- #26G Simpson Multi-Mull discharge door upgrade

APPLICATION

- To update and improve the control of an existing #26G Simpson Multi-Mull

SALES PARTNER

Simpson Technologies (Changzhou), Ltd.
Changzhou City, Jiangsu Province, China



科勒 KOHLER

www.kohler.com.cn

PRODUCTIVITY makes you more competitive

SYSTEM SIMPSON... OPTIMIZED SOLUTIONS DESIGNED FOR SPECIFIC NEEDS

WWW.SIMPSONGROUP.COM





Shanghai Kohler Company, Ltd.

Shanghai City, China

2008

EQUIPMENT

- #4-Cell Simpson Pro-Claim

APPLICATION

- Reclamation of green sand for reuse in a green sand molding system for iron sanitary castings.

SALES PARTNER

Simpson Technologies (Changzhou), Ltd.
Changzhou City, Jiangsu Province, China



科勒 KOHLER

www.kohler.com.cn

PRODUCTIVITY makes you more competitive

SYSTEM SIMPSON... OPTIMIZED SOLUTIONS DESIGNED FOR SPECIFIC NEEDS

WWW.SIMPSONGROUP.COM





CSR Yangtze Rolling Stock Co.

Tongling City, Anhui Province, China

2008

EQUIPMENT

- Simpson Stationary Speedslinger (2x)

APPLICATION

- A new foundry for China Southern Railway Group, the main supplier of heavy-duty locomotives, high-grade passenger trains, high-speed locomotives, and rail and subway vehicles for China's railways, to produce iron castings for the rail industry such as bogie and bolster castings.



SALES PARTNER

Simpson Technologies (Changzhou), Ltd.
Changzhou City, Jiangsu Province, China



PRODUCTIVITY makes you more competitive

SYSTEM SIMPSON... OPTIMIZED SOLUTIONS DESIGNED FOR SPECIFIC NEEDS

WWW.SIMPSONGROUP.COM





Ohm und Häner Metallwerk GmbH 2008

Olpe, Germany

EQUIPMENT

- #225G Simpson Multi-Mull

APPLICATION

- Aluminum casting foundry

SALES PARTNER

Simpson Technologies – Steinhausen, Switzerland

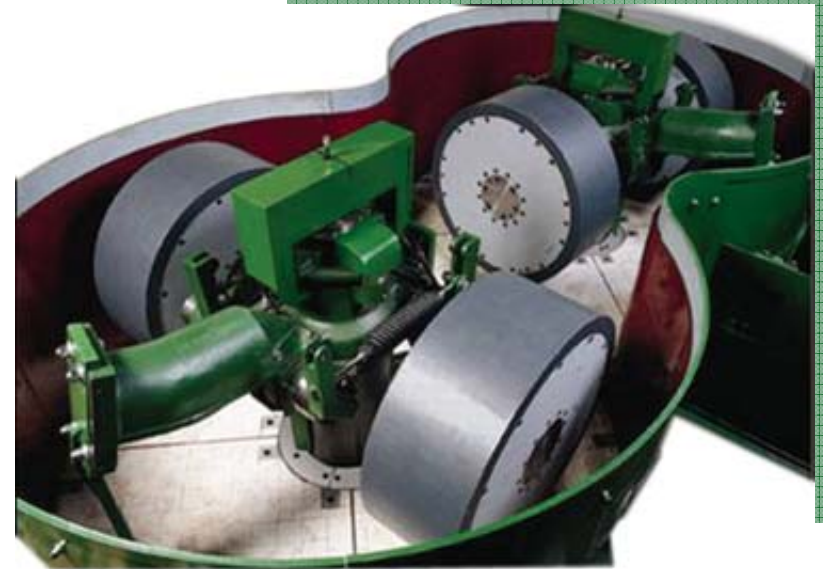

www.ohmundhaener.de

PRODUCTIVITY makes you more competitive

SYSTEM SIMPSON... OPTIMIZED SOLUTIONS DESIGNED FOR SPECIFIC NEEDS

WWW.SIMPSONGROUP.COM



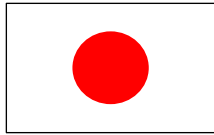

Fukushima Steel Works Co. Ltd.

2008

Sagamihara-shi, Kanagawa, Japan

EQUIPMENT

- #100B-250 Beardsley & Piper Speedmullor
- #18Mk2/2552 Simpson+Hartley Compactability Controller

APPLICATION

- to replace an obsolete Multi-Mull to prepare sand for an existing Sinto JSS-7 Jolt Squeeze molding line. This company produces large brake drum iron casting for truck and valve housing for construction machinery.



MANUFACTURED IN JAPAN UNDER LICENSE BY

Sintokogio Ltd. – Nagoya, Japan

www.f-seiko.co.jp



PRODUCTIVITY makes you more competitive

SYSTEM SIMPSON... OPTIMIZED SOLUTIONS DESIGNED FOR SPECIFIC NEEDS

WWW.SIMPSONGROUP.COM





slr-Eisenwerk Martinlamitz GmbH 2008

Schwarzenbach/Saale, Germany

EQUIPMENT

- #MC-200 Simpson Multi-Cooler

APPLICATION

- Grey & ductile iron castings

SALES PARTNER

Simpson Technologies – Steinhausen, Switzerland



www.slr-ewm.de

PRODUCTIVITY makes you more competitive

SYSTEM SIMPSON... OPTIMIZED SOLUTIONS DESIGNED FOR SPECIFIC NEEDS

WWW.SIMPSONGROUP.COM





Johann NEMETZ & Co GmbH

2008

Wiener Neustadt, Austria

EQUIPMENT

- #MC-100 Simpson Multi-Cooler (rebuilt)

APPLICATION

- Grey & ductile iron castings

SALES PARTNER

Simpson Technologies – Steinhausen, Switzerland



www.nemetzguss.at

PRODUCTIVITY makes you more competitive

SYSTEM SIMPSON... OPTIMIZED SOLUTIONS DESIGNED FOR SPECIFIC NEEDS

WWW.SIMPSONGROUP.COM





Victaulic Company

Drezdenko, Województwo Lubuskie, Poland

2009

EQUIPMENT

- #MC-200 Simpson Multi-Cooler

APPLICATION

- Grey & ductile iron castings

SALES PARTNER

Simpson Technologies – Steinhausen, Switzerland



www.victauliccastings.com

PRODUCTIVITY makes you more competitive

SYSTEM SIMPSON... OPTIMIZED SOLUTIONS DESIGNED FOR SPECIFIC NEEDS

WWW.SIMPSONGROUP.COM





FGUP PO Uralvagonzavod

2009

Nishny Tagil, Russia

EQUIPMENT

- #MC-200 Simpson Multi-Cooler

APPLICATION

· Grey & ductile iron castings. Uralvagonzavod is one of the most fast growing machine building companies in Russia.

SALES PARTNER

Simpson Technologies – Steinhausen, Switzerland



www.uvz.ru

PRODUCTIVITY makes you more competitive

SYSTEM SIMPSON... OPTIMIZED SOLUTIONS DESIGNED FOR SPECIFIC NEEDS

[WWW.SIMPSONGROUP.COM](http://www.simpsongroup.com)





Chauffagekar Industrial Co. 2010

Tehran, Iran

EQUIPMENT

An order of more than EUR 30,000 for a set of Simpson sand laboratory equipment featuring PFG Strength Machine, PNZ Wet Tensile Tester, PRA-MA motorized sand rammer, PMK Methylene Blue Clay Tester and a PWG moisture analyser MA35M

APPLICATION

Chauffagekar is Iran's leading producer of cast iron boilers for residential and industrial heating systems.

SALES PARTNER

Simpson Technologies – Steinhausen, Switzerland



PRODUCTIVITY makes you more competitive



CHAUFFAGEKAR

www.chauffagekar.com

SYSTEM SIMPSON... OPTIMIZED SOLUTIONS DESIGNED FOR SPECIFIC NEEDS

WWW.SIMPSONGROUP.COM





Kayseri Döküm Sanayii Ve Ticaret A.Ş.

Melikgazi / KAYSERÝ, Turkey

EQUIPMENT

An order of more than EUR 20,000 for a set of Simpson sand laboratory equipment featuring a PVF-C Minilab and PDU-D Permeability Tester.

APPLICATION

KAYDÖKSAN is one of the largest foundries in Turkey. The main products are automotive and machine parts which are made from grey cast iron and nodular cast iron with DISAMATIC molding.

SÄLES PARTNER

Meta•Mak Metalurji



PRODUCTIVITY makes you more competitive

SYSTEM SIMPSON... OPTIMIZED SOLUTIONS DESIGNED FOR SPECIFIC NEEDS

WWW.SIMPSONGROUP.COM

2010



www.kaydoksan.com.tr





MANDO Corporation

Kyonggi-Do, Korea

2010

EQUIPMENT

- #MC-50 Simpson Multi-Cooler
- #85B Simpson Speedmullor
- #18Mk2/2552 Simpson+Hartley Controller
- #90Mk2-5 Simpson bond dosing system

APPLICATION

- Ductile Iron foundry with DISA 230-B molding
- MANDO Corporation is the largest Korean automotive parts producer. The Pyeongtaek Business Division is a major producer of brake systems.

SALES PARTNER

Phil Corporation



MANDO

www.mando.com

PRODUCTIVITY makes you more competitive

SYSTEM SIMPSON... OPTIMIZED SOLUTIONS DESIGNED FOR SPECIFIC NEEDS

WWW.SIMPSONGROUP.COM





Dietermann GmbH + Co. KG

Viersen, Germany

2010

EQUIPMENT

- #3G-125 Simpson Mix-Muller w/VFD Drive
- 18Mk2/2552 Simpson+Hartley Controller
- 90Mk2-5 Simpson Bond dosing system

APPLICATION

60 tph sand system for an aluminum foundry with two HWS molding lines. This mixer replaces an Eirich mixer and was selected for its superior mixing performance and energy efficiency.

SALES PARTNER

Simpson Technologies – Steinhausen, Switzerland

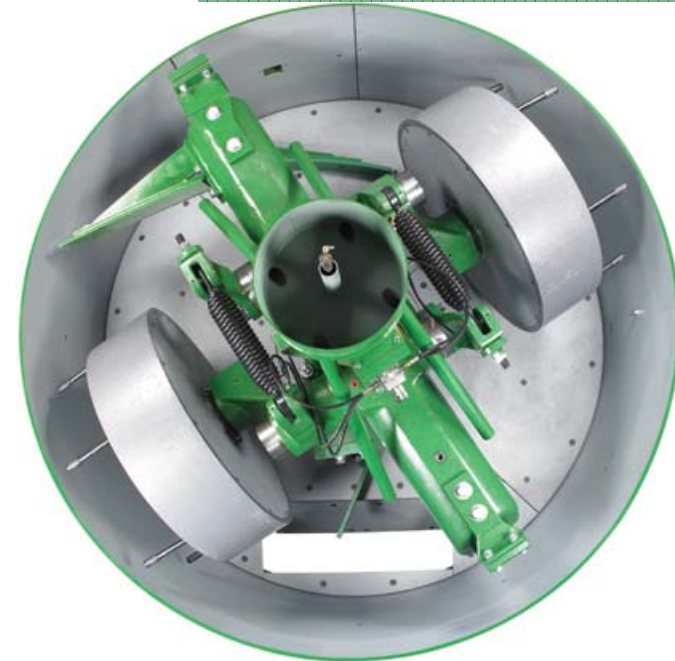

PRODUCTIVITY makes you more competitive

www.dietermann-guss.de

SYSTEM SIMPSON... OPTIMIZED SOLUTIONS DESIGNED FOR SPECIFIC NEEDS

WWW.SIMPSONGROUP.COM





Fundiciones Garbi, S.A.

Abadiano (Vizcaya), Spain

2010

EQUIPMENT

#MC-150 Simpson Multi-Cooler (rebuilt)

APPLICATION

Grey & ductile iron castings for general industrial applications.

SALES PARTNER

Simpson Technologies – Steinhausen, Switzerland



EURO-EQUIP
FOUNDRY ENGINEERING AND EQUIPMENT



www.fundicionesgarbi.es

PRODUCTIVITY makes you more competitive

SYSTEM SIMPSON... OPTIMIZED SOLUTIONS DESIGNED FOR SPECIFIC NEEDS

WWW.SIMPSONGROUP.COM



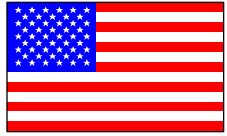

Deere & Company US-AG

Waterloo, Iowa, USA

2010

EQUIPMENT

- #26G Simpson Multi-Mull discharge door upgrade
- #17Mk2/2552 Simpson+Hartley Control System

APPLICATION

- Upgrade of the discharge door control system and the addition of a new Simpson+Hartley on-line control and automation system to improve the performance of an existing #26G Simpson Multi-Mull.

SALES PARTNER

Carpenter Brothers Inc.



Carpenter Brothers, Inc.

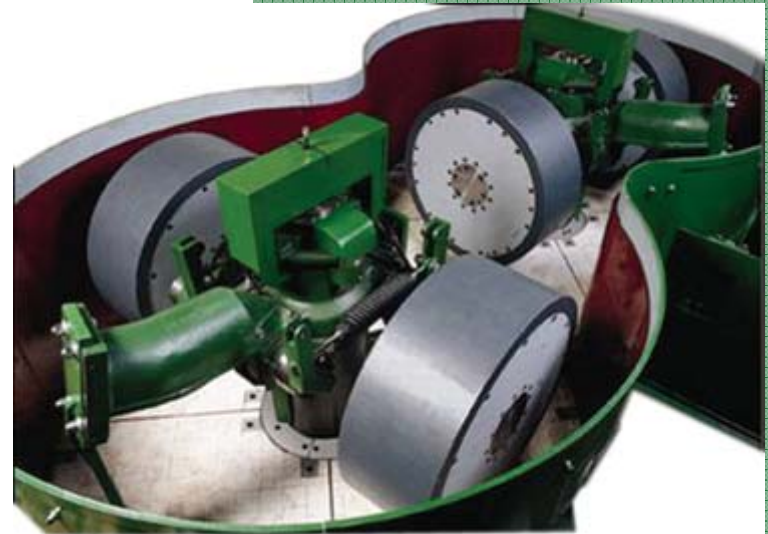

JOHN DEERE

www.deere.com

PRODUCTIVITY makes you more competitive

SYSTEM SIMPSON... OPTIMIZED SOLUTIONS DESIGNED FOR SPECIFIC NEEDS

WWW.SIMPSONGROUP.COM



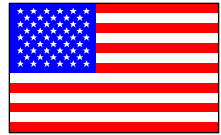

Manufacturer's Brass & Aluminum Foundry

Blue Island, IL USA

2009

EQUIPMENT

#1 1/2G Simpson Mix-Muller with VFD drive

18Mk2/2552 Simpson+Hartley control & automation system

45Mk2-5 Sand system hopper logic

APPLICATION

Bronze foundry with Sinto FBO III molding line wished to replace an existing States Ringmullor and improve the system performance and capacity. A 1 1/2G with special VFD drive capability will provide significantly increased capacity with better mixing and less energy consumption. A Simpson+Hartley 18Mk2/2552 will provide mixer group control and system automation.

SALES PARTNER

Carpenter Brothers



www.mbaf.us

PRODUCTIVITY makes you more competitive

SYSTEM SIMPSON... OPTIMIZED SOLUTIONS DESIGNED FOR SPECIFIC NEEDS

WWW.SIMPSONGROUP.COM



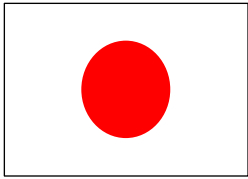

Tsubakimoto Iron Casting Co., Ltd. 2007

Saitama, Japan

EQUIPMENT

Model #2 1/2K Simpson Mix-Muller

APPLICATION

Iron castings

Sinto Seiatu ACE molding line

MANUFACTURED IN JAPAN UNDER LICENSE BY

Sintokogio Ltd. – Nagoya, Japan



PRODUCTIVITY makes you more competitive

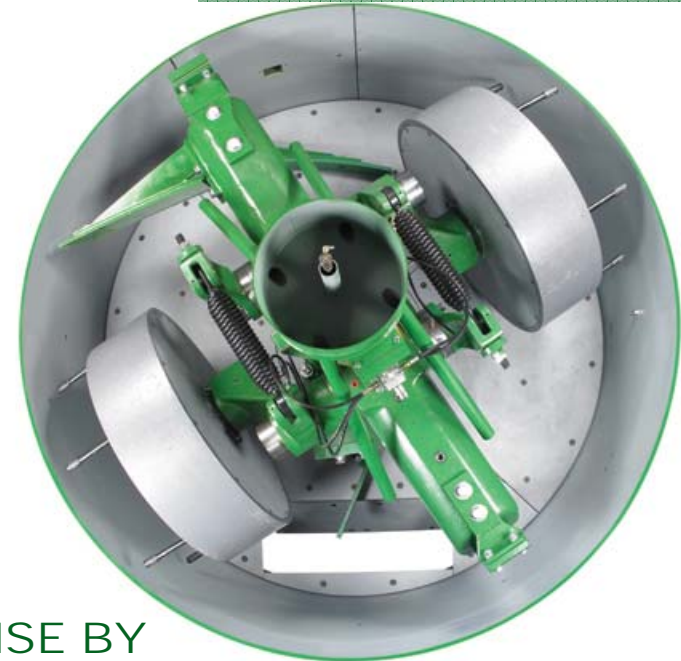

www.tsubakimoto.com

SYSTEM SIMPSON... OPTIMIZED SOLUTIONS DESIGNED FOR SPECIFIC NEEDS

WWW.SIMPSONGROUP.COM





Transnet Rail Engineering (Pty) Ltd. 2007

Bloemfontein, Free State, South Africa

EQUIPMENT

- #3G-125 Simpson Mix-Muller

APPLICATION

Railroad castings in a steel foundry application

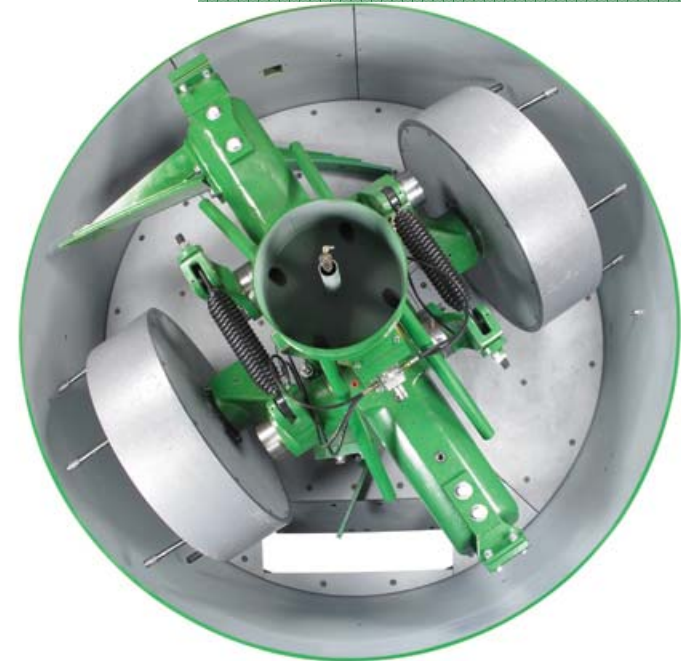

SALES PARTNER

DVN Marketing cc.



PRODUCTIVITY makes you more competitive

SYSTEM SIMPSON... OPTIMIZED SOLUTIONS DESIGNED FOR SPECIFIC NEEDS

WWW.SIMPSONGROUP.COM





Victaulic Company

Richmond Hill, ON Canada

1993

EQUIPMENT

#3G-125 Simpson Mix-Muller

1 1/2G Simpson Mix-Muller

Simpson+Hartley 18Mk2/2552 Compactability
Controller / Bond Determinator

Simpson+Hartley 90Mk2-1 Bond Dosing System

APPLICATION

Victaulic is the largest non-ferrous foundry in
Canada producing aluminum castings in green sand
with flaskless matchplate molding machines

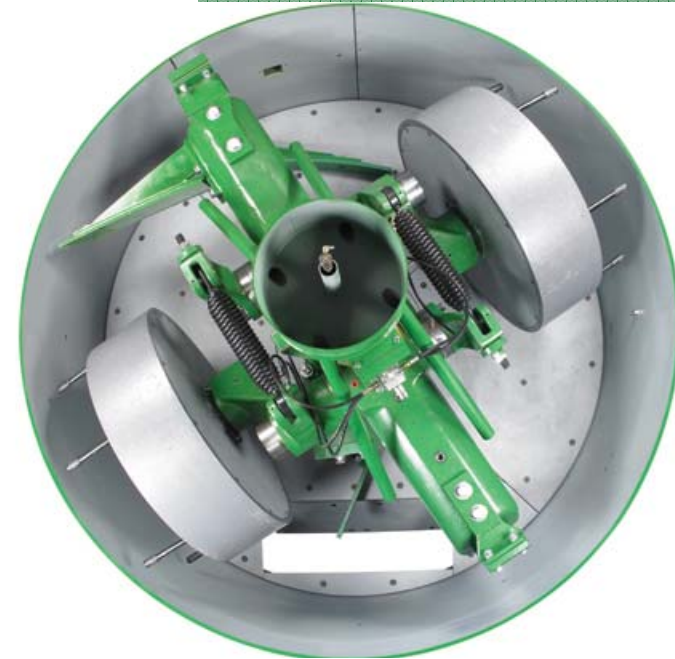

www.victauliccastings.com

PRODUCTIVITY makes you more competitive

SYSTEM SIMPSON... OPTIMIZED SOLUTIONS DESIGNED FOR SPECIFIC NEEDS

WWW.SIMPSONGROUP.COM



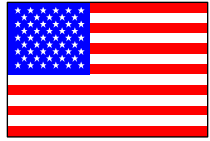

Grede Foundries Inc.

St. Cloud, MN USA

1999

EQUIPMENT

#MC-100 Simpson Multi-Cooler

#6G Simpson Mix-Muller w/VFD Drive

#18Mk2-2552 Simpson+Hartley Compactability Control

#90Mk2 Bond Dosing System

Simpson+Gerosa sand laboratory

APPLICATION

Ductile Iron castings

BMD Flask molding line



PRODUCTIVITY makes you more competitive

SYSTEM SIMPSON... OPTIMIZED SOLUTIONS DESIGNED FOR SPECIFIC NEEDS

WWW.SIMPSONGROUP.COM



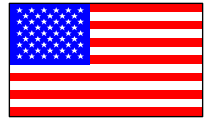

Hensley Industries Corp.

Dallas, Texas USA

2006

EQUIPMENT

#MC-100 Simpson Multi-Cooler

#6G Simpson Mix-Muller

#2552 Simpson+Hartley Compactability Controller

#90Mk2 Simpson+Hartley bond dosing system

APPLICATION

Steel Castings for mining equipment

HWS DAFM-SD5 Seiatsu molding line

60 tph sand plant

SALES PARTNER

Canfield & Joseph, Inc.



PRODUCTIVITY makes you more competitive

SYSTEM SIMPSON... OPTIMIZED SOLUTIONS DESIGNED FOR SPECIFIC NEEDS

WWW.SIMPSONGROUP.COM





Takaoka Lioho (Tianjin) Industries

Tianjin, China

2007

EQUIPMENT

Model #MSG-60 Simpson Mix-Mullers (2x)

APPLICATION

Automotive castings
Sinto Seiatu ACE molding line

MANUFACTURED IN JAPAN UNDER LICENSE BY

Sintokogio Ltd. – Nagoya, Japan



PRODUCTIVITY makes you more competitive



AT AISIN TAKAOKA CO.,LTD

www.at-takaoka.co.jp

SYSTEM SIMPSON... OPTIMIZED SOLUTIONS DESIGNED FOR SPECIFIC NEEDS

WWW.SIMPSONGROUP.COM





Toyota Industry (Kunshan) Co., Ltd. 2003

Kunshan E.&T. Development Zone, Jiangsu Prov., China

EQUIPMENT

Model #MSK-60 Simpson Mix-Muller

APPLICATION

Automotive castings

Sinto Seiatu ACE molding line

MANUFACTURED IN JAPAN UNDER LICENSE BY

Sintokogio Ltd. – Nagoya, Japan



www.toyota-industries.com

PRODUCTIVITY makes you more competitive

SYSTEM SIMPSON... OPTIMIZED SOLUTIONS DESIGNED FOR SPECIFIC NEEDS

WWW.SIMPSONGROUP.COM



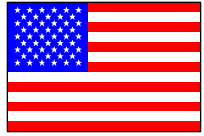

Lufkin Industries, Inc.

Lufkin, TX USA

2006

EQUIPMENT

4-Cell Simpson Pro-Claim (8x)

APPLICATION

40 tph reclamation of Phenolic Urethane Pep-Set bonded sands

medium to large, low to medium volume ductile and gray iron castings .

SALES PARTNER

Canfield & Joseph



PRODUCTIVITY makes you more competitive

SYSTEM SIMPSON... OPTIMIZED SOLUTIONS DESIGNED FOR SPECIFIC NEEDS

WWW.SIMPSONGROUP.COM



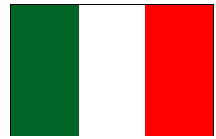

Impianti e Macchine Fonderia S.r.l. 2011

Luino, Italy

EQUIPMENT

- (2x) 4-Cell Simpson Pro-Claims

APPLICATION

Green sand to core sand reclamation

Combination mechanical/thermal reclamation plant with IMF srl of Italy for installation at the Union Foundry Company foundry in Anniston, Alabama USA.

SALES PARTNER

IMF Srl. - Italy



PRODUCTIVITY makes you more competitive



www.tylerunion.com

SYSTEM SIMPSON... OPTIMIZED SOLUTIONS DESIGNED FOR SPECIFIC NEEDS

WWW.SIMPSONGROUP.COM



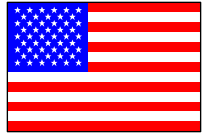

Metal Technologies Inc. - Auburn 2011

Auburn, IN USA

EQUIPMENT

- #100B-250 Simpson Speedmullor (4x)
- #18Mk2/2552 Simpson+Hartley controller (4x)
- #90Mk2-5 Simpson Hartley bond dosing system (4x)

APPLICATION

Leading grey & ductile iron automotive foundry is increasing capacity with 2x new DISA 231Xfast moldings lines in addition to 2x existing 230X machines. To meet quality and capacity demands of new molding lines MTI is removing 4x Eirich RV-23 mixers and replacing them with 4x 100B-250 Simpson Speedmullors with Hartley controls.

SALES PARTNER



Metal Technologies

www.metal-technologies.com

PRODUCTIVITY makes you more competitive

SYSTEM SIMPSON... OPTIMIZED SOLUTIONS DESIGNED FOR SPECIFIC NEEDS

WWW.SIMPSONGROUP.COM



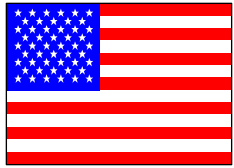

ThyssenKrupp Waupaca Inc.

Waupaca, WI USA

2012

EQUIPMENT

- 2-Cell Simpson Pro-Claim (2x)

APPLICATION

Green sand to core sand reclamation

Combination mechanical/thermal reclamation plant with IMF srl of Italy for installation at the ThyssenKrupp Waupaca Company foundry in Waupaca, WI USA.



SALES PARTNER



ThyssenKrupp

www.thyssenkruppwaupaca.com

PRODUCTIVITY makes you more competitive

SYSTEM SIMPSON... OPTIMIZED SOLUTIONS DESIGNED FOR SPECIFIC NEEDS

WWW.SIMPSONGROUP.COM





SYSTEM SIMPSON... OPTIMIZED SOLUTIONS DESIGNED FOR SPECIFIC NEEDS

WWW.SIMPSONGROUP.COM

